

深圳市方磁電子有限公司

SHENZHEN FOUNDS ELECTRONICS CO., LTD

【物料承認書】

APPROVAL SHEET

客戶 (Customer) : _____

產品名稱 (Description) : 功率電感

客戶料號 (Cus P/N) : _____

料號 (Part NO) : FSNR6015系列

日期 (Date) : 2018.10.18

版本 (Version) : A0

核准 APPROVED BY	審核 CHECKED BY	製作 DRAWN BY
TopoCheng	VincentShang	AbbyShi

Please sign back after confirmation:

Client signature: Qualified Unqualified

批准 APPROVAL	審核 CHECKED	檢驗 CONFORM

地址 (Address) : 深圳市寶安區新安街道裕安二路 131 號

C33 科創園 2 棟 209 室

電話 (TEL) : 0755-83222650

傳真 (FAX) : 0755-83222656

<http://www.ele-founds.com>



【Version of Changed Record】

Rev.	Effective Date	Changed Contents	Change Reasons	Approved By
A0	2018.10.18	New release	/	TopoCheng

1. Shape and Dimension (Unit:mm)

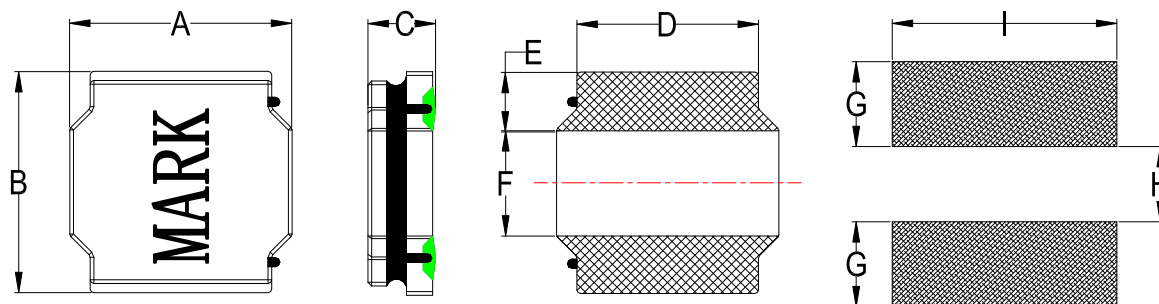

A	B	C	D	E	F	G	H	I
6.0 ± 0.3	6.0 ± 0.3	1.5 ± 0.3	4.9 ± 0.3	1.55 ± 0.3	2.9 ± 0.3	1.7 Ref	2.8 Ref	5.7 Ref

注：喷码尺寸长 3.6 ± 0.5mm, 宽 2.5 ± 0.5mm

2. Electronic Characteristics List

Part Number	Inductance (uH)	Tolerance (±%)	DCR (mΩ) ±30%	Isat (A)	Irise (A)	Test Condition	Marking
FSNR6015-1R2N	1.2	30	35	4.20	2.80	100KHz /0.25V	1R2
FSNR6015-2R2N	2.2	30	50	3.10	2.30	100KHz /0.25V	2R2
FSNR6015-3R3N	3.3	30	60	2.60	2.10	100KHz /0.25V	3R3
FSNR6015-4R7M	4.7	20	90	2.10	1.90	100KHz /0.25V	4R7
FSNR6015-5R6M	5.6	20	92	2.00	1.80	100KHz /0.25V	5R6
FSNR6015-6R8M	6.8	20	115	1.80	1.65	100KHz /0.25V	6R8
FSNR6015-100M	10	20	155	1.45	1.35	100KHz /0.25V	100
FSNR6015-150M	15	20	220	1.20	1.20	100KHz /0.25V	150
FSNR6015-220M	22	20	320	1.00	1.00	100KHz /0.25V	220

Isat :

DC Saturation Current that will cause initial inductance to drop approximately 30% max.

Irise :

DC Current that will cause an approximate ΔT of 40 °C

Measuring Instrument :

L:HIOKI3532-50

DCR:HIOKI 3540

Isat / Irise:HP4284+42841A

3. General Characteristics

3-1. Storage Temperature range : $-40^{\circ}\text{C} \sim +105^{\circ}\text{C}$

3-2. Operating temperature range: $-40^{\circ}\text{C} \sim +125^{\circ}\text{C}$ (Including coil's self temperature rise)

3-3. External appearance : No external defects can be found in the visual inspection.

3-4. Electrode strength : No electrode detachment should be found when the device is pushed in two directions of X and Y with the force of 10.0N for 60 ± 2 seconds after soldering between copper plate and the electrodes.
(Refer to figure at right)

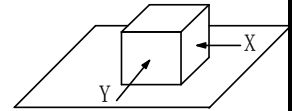

3-5. Vibration test : Inductance deviation is within $\pm 10.0\%$ after 1 hour sweeping vibration in each three directions, namely, forward and backward, up and down, right and left. The frequency is $10 \sim 55 \sim 10\text{Hz}$ and the amplitude of 1 minute cycle is 1.5mm PP.

3-6. Recommended reflow condition:

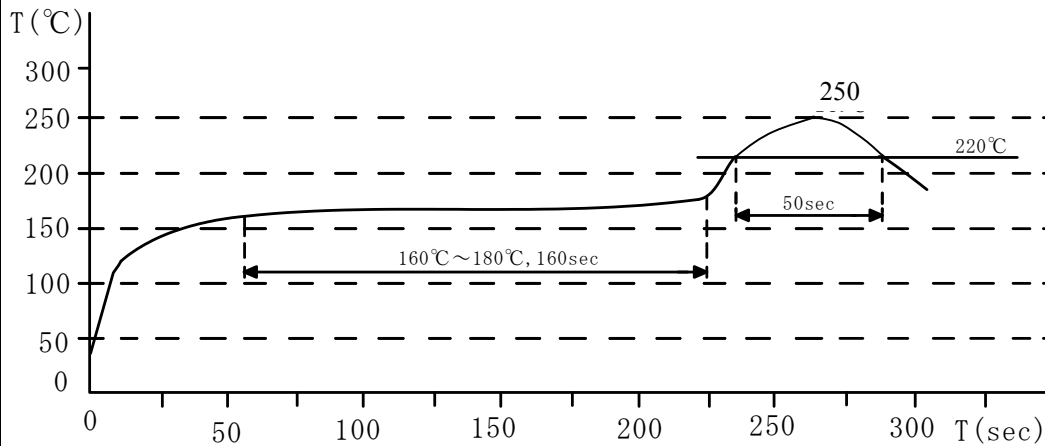

3-7. Humidity test : Inductance deviation is within $\pm 5.0\%$ after 96 ± 4 hours test under the condition of relative humidity of $90 \sim 95\%$ and temperature of $60 \pm 2^{\circ}\text{C}$, and 1 hour storage under room ambient conditions after the device is wiped with dry cloth.

LEAD-FRE

RoHS
Compliance

4. Construction and materials

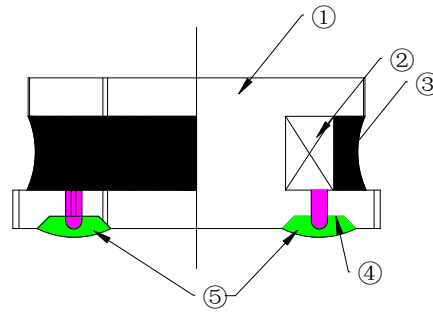

No.	Part name	Material	Ceaiya P/N
①	Drum Core	Ni-Zn Ferrite Core	TW
②	Wire	Polyurethane enameled copper wire	YLSL
③	Adhesive	Epoxy Resin Magnetic Powder	
④	Plating Electrodes	Plating: Ag 10-20 μm Ni 1-3 μm Sn 3-7 μm	
⑤	Outer Electrodes	Top surface solder coating Sn99%、Ag0.3%、Cu0.7%	YX

5. Package Specification

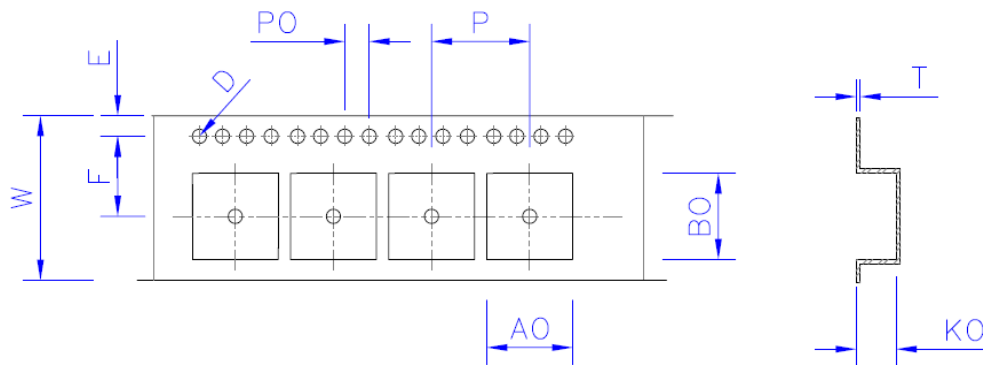

ITEM	W	A0	B0	K0	P	F	E	P0	P2	T
DIM	12.00	6.3	6.3	1.8	8.00	5.50	1.75	4.00	2.00	0.30
TOLE	±0.3	±0.1	±0.1	±0.1	±0.1	±0.15	±0.1	±0.1	±0.1	±0.05

6. CARRIER REEL DIMENSIONS:

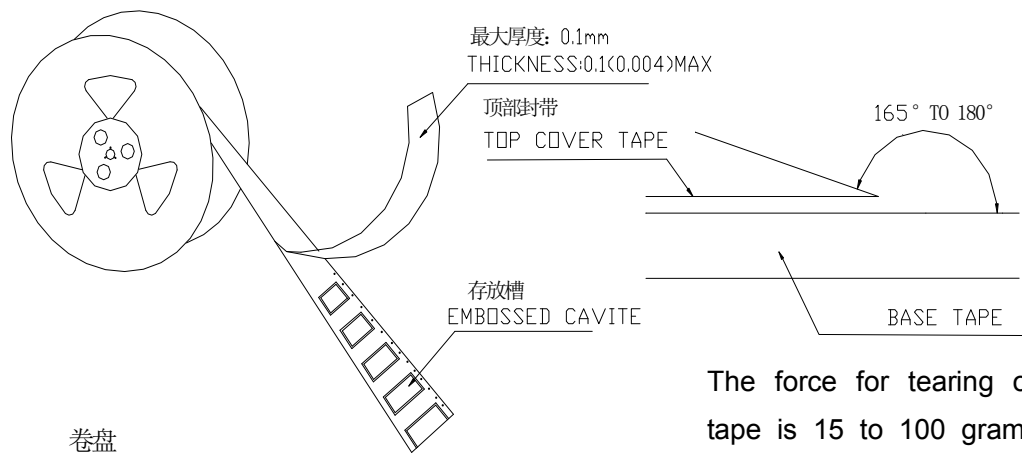

The force for tearing off cover tape is 15 to 100 grams in the arrow direction/按箭头的方向施加 15 克至 100 克力撕开

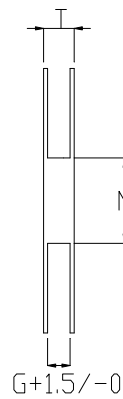
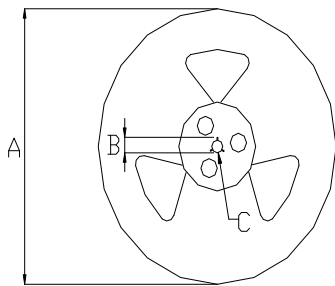

Unit: mm

Type	A	B	C	G	N	T
12mm	330	21±0.8	13±0.4	12.4	100	20.4

7. PACKAGE SPECIFICATION :

3.0KPCS/Reel 9.0KPCS/Inner Box 27KPCS/Outer Box

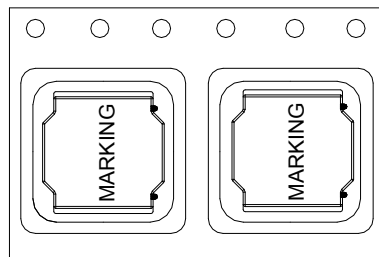

Visual Inspection Standard of Product

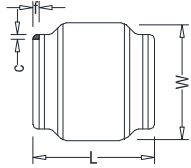
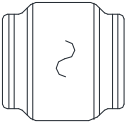
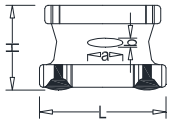
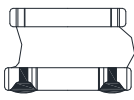
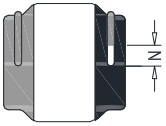
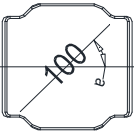
No.	Defect Item	Figure	Rejection Identification	Acceptance
1	Core Defect		The defect length(c or f)more than L/6 or W/6 , NG	AQL=0.65
2	Core Crack		Visual cracks , NG	AQL=0.65
3	Starvation		(1)Resin starved length a more than L/2, NG (2)When L>2mm,b>H/2, NG (3)When L≤2mm, b don't control	AQL=0.65
4	Excessive glue		The length, width or height of product beyond specified value, NG	AQL=0.65
5	Cold Solder		(1)For CR2520** Series , cold solder N>0.5mm,NG (2)For other series, cold solder N>1mm,NG	AQL=0.65
6	Marking Defect		The marking angle a>45° , NG	AQL=0.65

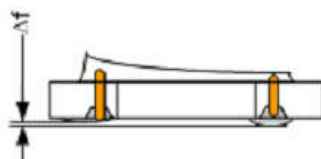

Δf: Clearance between terminal and the surface of plate must be 0.2mm max when coil is placed on a flat plate.